

S100

CNC UNIVERSAL INTERNAL CYLINDRICAL GRINDING MACHINE



 **STUDER**



APPLICATIONS

STUDER S100 IN USE

The S100 CNC universal internal cylindrical grinding machine offers the proven STUDER quality and highest precision in standard internal cylindrical grinding operations at an excellent price-performance ratio. The S100 covers the wide range of internal, face and external grinding applications. This makes it the ideal universal internal cylindrical grinding machine for the entry-level segment. Many suitable workpieces can be found in the compressor, hydraulic, machine tool, aerospace and tooling industries.



S100

DIMENSIONS

- Workpiece length including clamping device: max. 550 mm (21.65")
- Workpiece diameter: max. 420 mm (16.53")
- External grinding diameter: max. 420 mm (16.53")
- Internal grinding diameter: max. 300 mm (11.81")
- Internal grinding length: 200 mm (7.87")

HARDWARE

- Wheelhead either with 2.5°Hirth manual or 1° Hirth automatic
- Frequency-controlled belt spindles for external and internal grinding up to 60 000 rpm
- Manual control unit for set-up close to the grinding process
- Granitan® S103 mineral casting machine base

SOFTWARE

- StuderPictogramming: Programming support using pictograms
- Operator-guided set-up
- Manual grinding cycle for one workpiece seat
- Short set-up and changeover times with STUDER QuickSet and automatic grinding spindle turret

YOUR ADVANTAGES

- Short processing time thanks to complete machining
- Highest precision thanks to perfect interaction of hardware and software
- Intuitive, user-oriented and efficient operation
- Good ergonomics thanks to easy access to the grinding area
- Ecological thanks to targeted measures for reduced energy consumption and sustainable use



«The ergonomic machine for the entry-level segment.»



GRANITAN® S103 MINERAL CASTING MACHINE BED

The material structure developed by STUDER to its own formula and proven over the years is produced in a plant using state-of-the-art industrial techniques. The excellent dampening characteristics of the machine bed ensure outstanding surface quality of the ground parts. The service life of the grinding wheel is also increased, leading to reduced non-productive times. Temporary temperature fluctuations are largely compensated by the favorable thermal behavior of Granitan®. This provides high dimensional stability throughout the day. The guideway system for the longitudinal and cross slides is formed directly in the machine bed and is coated with the Granitan® S200 wear-resistant guideway surfacing material. The guideways offer the highest possible accuracy through the entire speed range with high load capacity and dampening. Thanks to the robust and maintenance-free design, these excellent guideway characteristics are retained almost indefinitely.

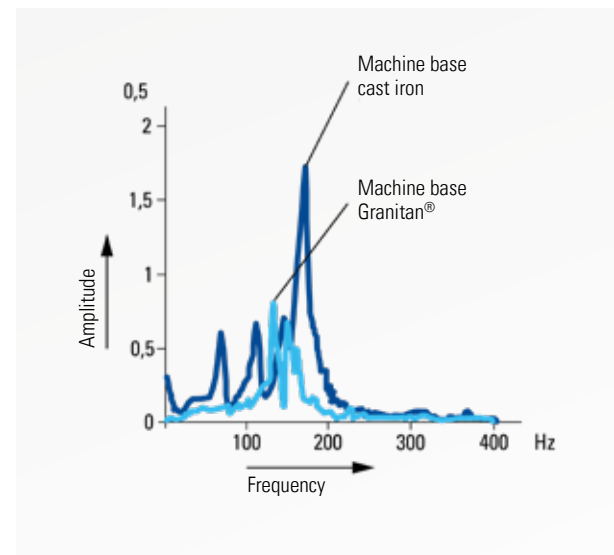

- Vibration-dampening
- Thermally stable
- Non-wearing

LONGITUDINAL AND CROSS SLIDES

The V and flat guideways for the longitudinal and cross slides with their patented surface structure guarantee outstanding precision and enable excellent straightness in long bores, for example.

The slides are advanced by circulating ball screws, which are connected to the servomotor via torsion-resistant couplings.



- High geometrical traversing precision
- Auxiliary scale for set-up and changeover
- Effective covering of the guideways



WHEELHEAD

Do you want to reduce set-up and changeover costs? You can achieve it with this machine, particularly in individual component or small-batch production. The grinding spindle turret with several grinding spindles and quick set-up with QuickSet make it possible. Increase efficiency through complete machining in a single clamping. The S100 manages internal, external and face grinding effortlessly.

- Complete machining
- Belt spindles for internal and external grinding
- Max. 2 tools (1×internal, 2×internal, or 1×internal / 1×external)
- With optional measuring probe
- 3 different wheelhead configurations (fixed, Hirth 2.5° manual, Hirth 1° automatic)



WORKHEAD

The workheads, manufactured in premium, solid STUDER quality, achieve a roundness accuracy of 0.0004 mm (0.000,016") during live spindle grinding. Easy cylindricity correction helps to achieve perfect results during live spindle grinding. Customized workpiece clamping systems can easily be used.

- High roundness accuracy 0.0004 mm (0.000,016")
- Low-maintenance
- Air lift

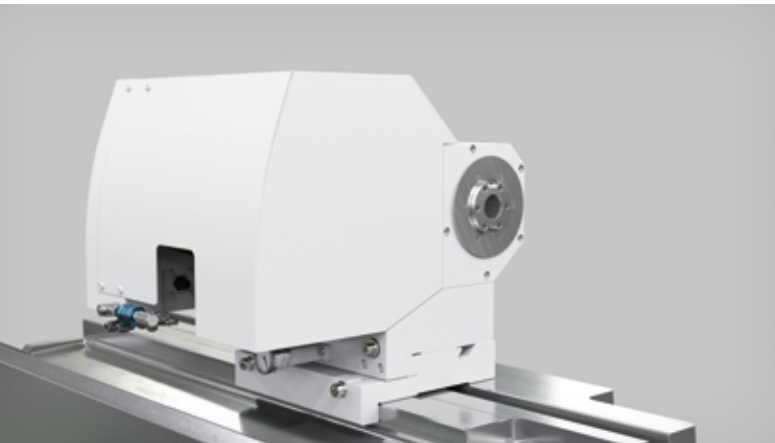

Chuck workhead MT4/70

Thanks to the design (with drive via a belt at the rear), high loads are possible during live spindle grinding. The drive power is 1.8 kW.

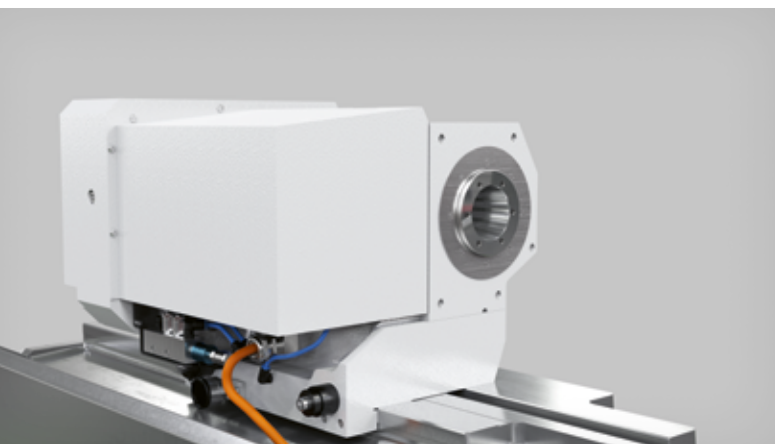

Chuck workhead ISO50/110

The workhead design (with drive via a belt at the rear) enables very high loads during live spindle grinding. The drive power is 2.5 kW.

DRESSING

An easy-cutting grinding wheel is essential for cost-effective and high-quality grinding. STUDER offers a wide variety of dressing units, enabling the dressing process to be flexibly and optimally matched to the specific workpiece, tool, and material characteristics. The grinding wheel reference points (T-numbers) are another STUDER speciality.

These allow programming with nominal dimensions, which makes grinding program development much easier.



Rotary dressing

Rotary dressing tools are particularly suitable for dressing CBN and diamond grinding wheels.

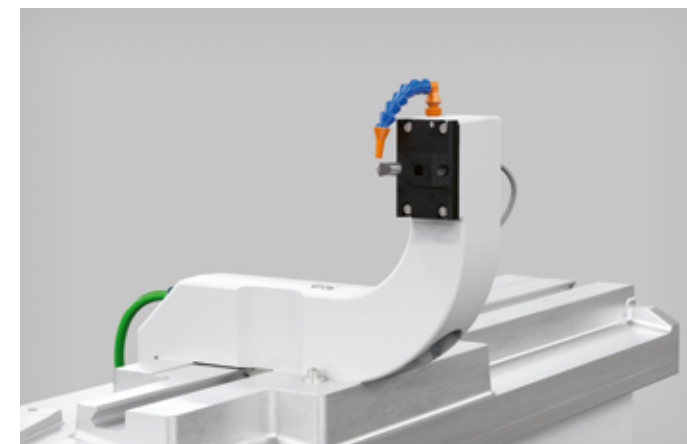

Stationary dressing

The clamping surface can accommodate various fixed dressing tools.



MACHINE CONTROL AND OPERATION

The Fanuc Oi-TFP CNC control with active colour flat screen (10.4") is extremely reliable and optimally matched to the drive elements. The electrical enclosure is bolted to the machine bed. The electrical equipment complies with established safety standards and is EMC-tested.

All controls are clearly and ergonomically arranged. An important role is played by the manual control unit, which facilitates set-up close to the grinding process. A special function, the electronic contact detection, reduces non-productive to a minimum.

- Manual control unit (with mechanical handwheel)
- EMC-tested electrical enclosure
- Ergonomically arranged controls
- Latest software technology
- StuderPictogramming



1 Machine control
2 Manual control unit

PROGRAMMING

The sophisticated mechanical engineering concept is supplemented by a grinding software program developed in-house by STUDER and constantly optimised in cooperation with users.

This software offers:

- StuderPictogramming: The operator strings the individual grinding cycles together and defines his grinding process.
- Grinding and dressing cycles can be freely programmed to optimise the grinding process.
- The StuderGRIND programming software allows programming on a PC or laptop.

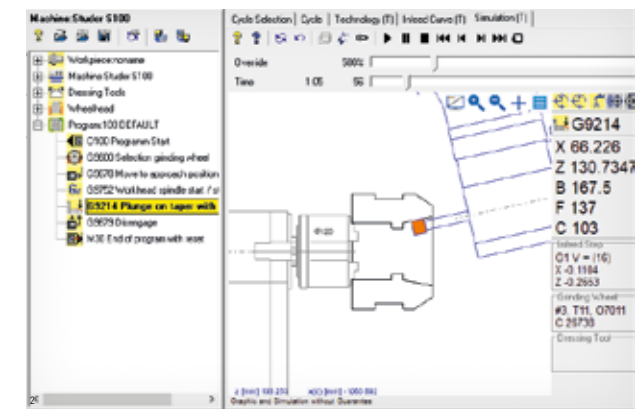

1 StuderPictogramming
2 StuderGRIND programming software

EXPANSION OPTIONS

The S100 is one step ahead of the constant changes and high demands of today's world. Thanks to a wide range of units and options, flexible extensions of the range of applications can be realized even at short notice.

The following options are available:

- Electronic contact detection
- Manual balancing
- «Micro-functions»
- StuderGRIND offline programming station
- Simple PDA interface
- OPC-UA interface
- Automatic sliding door
- B3-I/O loader interface

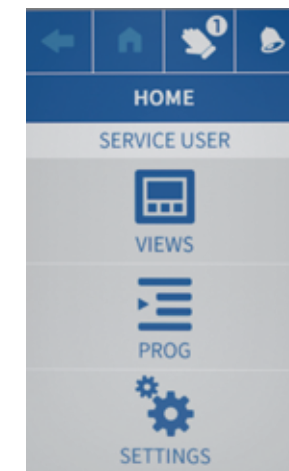



CUSTOMER CARE

CUSTOMER CARE – WE ARE HERE TO HELP

Our products should fulfill customer requirements for as long as possible, operate cost-effectively, function reliably and be constantly available.

From «start up» through to «retrofit» – our Customer Care is there for you throughout the working life of your machine. More than 200 expert service contacts are available to support you locally all over the world, in 10 different languages.

- We provide you with fast, straightforward support.
- We help you increase your productivity.
- We work professionally, reliably and transparently.
- We provide a professional solution to your problems.

UNITED GRINDING DIGITAL SOLUTIONS™

Within UNITED GRINDING Digital Solutions™ we develop solutions to help you simplify processes, increase the efficiency of your machines and improve overall productivity.

Under the headings of CONNECTIVITY, USABILITY, MONITORING and PRODUCTIVITY we are constantly working on new solutions to make your working life easier in the age of digitalization.

You can find out more about the services of UNITED GRINDING Digital Solutions™ on our website under the Customer Care section.



Start up
Commissioning
Warranty extension



Qualification
Training
Product support



Prevention
Maintenance
Inspection



Service
Customer service
Customer consultation
HelpLine



Digital Solutions
Remote Service
Service Monitor
Production Monitor

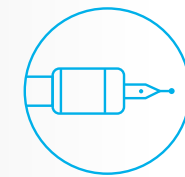

Materials
Spare parts
Replacement parts
Accessories



Rebuild
Machine overhaul
Assembly overhaul



Retrofit
Modifications
Retrofits

TECHNICAL DATA

MAIN DIMENSIONS

Swing diameter over the table	max. 425 mm (16.73")
Workpiece diameter	max. 420 mm (16.53")
Internal grinding diameter	max. 300 mm (11.8")
External grinding diameter	max. 420 mm (16.53")
Workpiece length (incl. chuck workhead MT4)	max. 550 mm (21.65")
Internal grinding length	max. 200 mm (7.87")
External grinding length	max. 450 mm (17.71")

TRANSVERSE AXIS X

Max. travel	285 mm (11.22")
Speed	0.001–10 000 mm/min (0.000,040–394 ipm)
Resolution	0.00001 mm (0.4 mill")

LONGITUDINAL AXIS Z

Max. travel	800 mm (31.5")
Speed	0.001–20 000 mm/min (0.000,040–787 ipm)
Resolution	0.00001 mm (0.4 mill")

WHEELHEAD

Spindle set-up	Fixed	Turret	Turret
Max. number of spindles	1	2	2
Swivel axis	–	Hirth 2.5° manual	Hirth 1° automatic
Swiveling range	–	– 10° to +190°	– 10° to +190°

Internal grinding

Mounting bore for internal grinding spindle	Ø 100 mm
Speeds	20 000 / 40 000 / 60 000 rpm
Grinding mandrel length (swiveling on the turret)	max. 175 mm (6.9")

External grinding

Peripheral speed	50 m/s
Fitting taper	1 : 10 / Ø 63 mm
Grinding wheel	Ø 400×40×127 mm F1N (15.74"×1.57"×5.00")
Drive power	max. 6.8 kW

Options

Length positioning active	
Manual balancing	
Hydraulically swiveling dressing device	

CHUCK WORKHEAD

Rpm range	1 – 1 000 rpm	1 – 650 rpm
Fitting taper	MT4	ISO50
Spindle feedthrough	Ø 26 mm (1.02")	Ø 50 mm (1.96")
Drive power	1.8 kW	2.5 kW
Load for live spindle grinding	100 Nm (73.8 ft-lb)	250 Nm (184 ft-lb)
Roundness accuracy during live spindle grinding	0.0004 mm (0.000,016")	0.0004 mm (0.000,016")

C-axis for form grinding

C-axis, indirect measuring system	0.0001°	0.0001°
-----------------------------------	---------	---------

CONTROL UNIT

FANUC Oi-TFP with integrated screen	10.4"
-------------------------------------	-------

CONNECTED LOADS

Total connected load	22 kVA
Air pressure	5.5 bar (80 psi)
Extraction capacity for cooling lubricant mist	900–1 300 m ³ /h (31,783–45,909 ft ³ /h)

MACHINE LAYOUT

Machine dimension LxW	3 090×2 100 mm (121.65"×82.67")
Total weight	4 500 kg (9920 lbs)

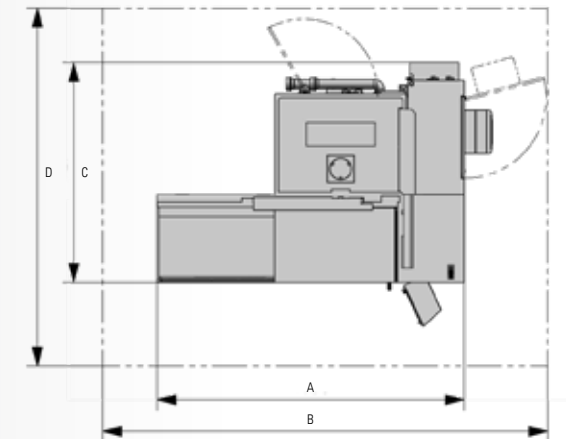
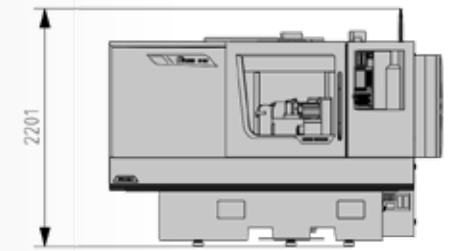

DIMENSIONS

A	B	C	D
3090 mm	3620 mm	2100 mm	3500 mm

The information given is based on the technical levels of our machines at the time of this brochure going to print. We reserve the right to further develop our machines technically and make design modifications. This means that the dimensions, weights, colors, etc. of the machines supplied can differ. The diverse application possibilities of our machines depend on the technical equipment specifically requested by our customers. The equipment specifically agreed with the customer is therefore exclusively definitive for the equipping of the machines, and not any general data, information or illustrations.

FRITZ STUDER AG

The name STUDER stands for more than 110 years of experience in the development and production of precision cylindrical grinding machines. «The Art of Grinding.» is our passion, highest precision is our aim and top Swiss quality is our benchmark.

Our product line includes both standard machines, as well as complex system solutions in high-precision cylindrical grinding for machining small and medium-sized workpieces. In addition we offer software, system integration and a wide range of services. As well as receiving a complete tailor-made solution the customer also benefits from our 110 years of know-how in relation to the grinding process.

Our customers include companies from the machine tool industry, automotive, tool and die makers, the aerospace industry, pneumatics/hydraulics, electronics/electrical engineering, medical technology, the watch industry and contract manufacturing. They value maximum precision, safety, productivity and longevity. As one of the market and technology leaders in universal, external, internal cylindrical and non-circular grinding, with 25 000 delivered systems, STUDER has stood for precision, quality and longevity for decades. STUDER's products and services include hardware, software and a wide range of services in the pre- and after-sales sector.



UNITED GRINDING GROUP

UNITED GRINDING Group is one of the world's leading manufacturers of grinding, eroding, laser, and measuring machines as well as machine tools for additive manufacturing. With roughly 2 500 employees at more than 20 manufacturing, service, and sales locations, the Group is organized in a customer-oriented and efficient way.

Through its MÄGERLE, BLOHM, JUNG, STUDER, SCHAUDT, MIKROSA, WALTER, EWAG, and IRPD brands, as well as competence centers in America and Asia, UNITED GRINDING offers broad application expertise, a large product portfolio, and a full range of services for the production of high-precision components.

«We want to make our customers even more successful»

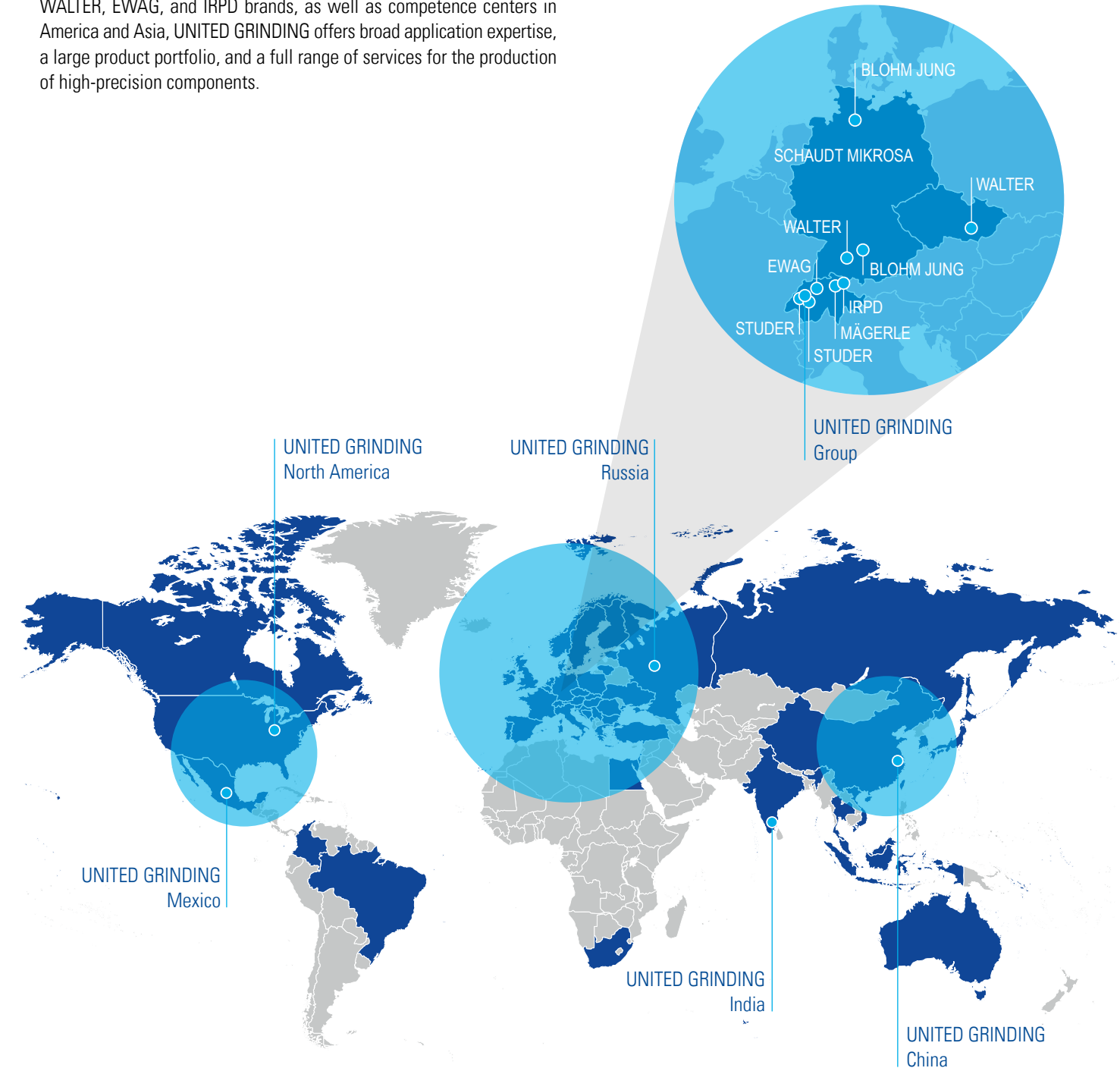



Fritz Studer AG
3602 Thun
Switzerland
Tel. +41 33 439 11 11
info@studer.com
studer.com



ISO 9001
VDA6.4
certified

