

VOUMARD 1000

The innovative platform concept for
internal and external cylindrical grinding



VOUMARD
WWW.HARDINGE.COM

 **HARDINGE®**

VOUMARD 1000



WORK HEAD WITH DIRECT DRIVE 200

- For high-precision cylindrical grinding
- Rotating speed 1-1,000 rpm
- Roundness accuracy <math>< 0.4 \mu\text{m}</math>
- Lower part with fine adjustment $\pm 0.01^\circ$

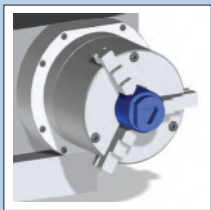

C-AXIS 200 (OPTIONAL)

- For non-circular workpieces
- For thread grinding

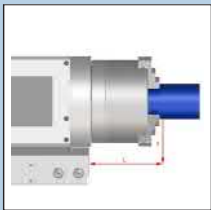

LOAD WITH CHUCKED WORK

- 320 Nm with direct drive



WORK HEAD WITH DIRECT DRIVE 50

- For high-precision cylindrical grinding
- Rotating speed 1-3,000 rpm
- Roundness accuracy <math>< 0.4 \mu\text{m}</math>
- Lower part with fine adjustment $\pm 0.01^\circ$

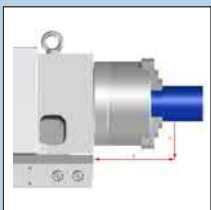

LOAD WITH CHUCKED WORK

- 100 Nm with direct drive



ONE-OF-A-KIND KINEMATICS

- Reduction to two highly accurate linear and rotational axes each with positioning in nanoscale
- No auxiliary axes are necessary for dressers or measuring systems
- C-axis for non-cylindrical workpieces and thread grinding
- Simplified set-up and increased accuracy
- A compact machine with a wide range of parts of up to $\varnothing 300 \times 300$ mm

HYDROLIN® - HIGH-DYNAMICS HYDROSTATIC LINEAR AXES

- Positioning accuracy in nanoscale
- The wear-free linear motors feature integrated heat dissipation

BASIS

- FEM-optimized casting bed for high stability and durability
- Mechanical separation of machine and periphery for thermal stability and prevention of vibrations

THE ULTIMATE INTERPLAY OF PRECISION & PERFORMANCE



ERGONOMICS

- Optically and ergonomically advanced design
- Good overview of the grinding process
- Centrally arranged and easily accessible interfaces for table constructions
- Swivel- and height-adjustable control panel for optimized usability
- Well thought-out accessibility for inexpensive maintenance and service

CNC CONTROL 31i

- 19" LCD color screen with touch function
- BLUE Solution teach-programming with OBJECT Guide for guided and easy program creation on workpiece
- Windows 10 IoT IPC operating system
- A handheld device with security and setup functions
- Ethernet (RJ45) and USB 2.0 connection

HYDROSTATIC B-AXIS

- Fully-fledged NC axis
- Pre-stressed hydrostatic guidance
- Direct drive



HYDROSTATIC X- / Z-AXIS

- Pre-stressed hydrostatic guidance
- No stick-slip, no wear
- The finest correction possibilities
- High form accuracy
- Direct drive

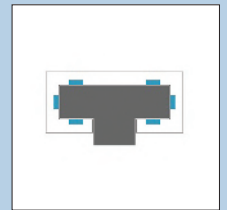

AUTOMATIC SLIDING DOOR

- Relief for the operator
- Faster workpiece changeover times



EASY TRANSPORTATION

- Forklift
- Hook lifting machine
- Fast and easy installation



AUTOMATION

- Profinet interface
- Loading cell with high autonomy
- Project-specific solutions on request

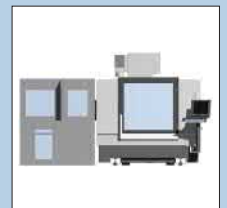

WORKPIECE HOLDER WITH DRESSING TURRET

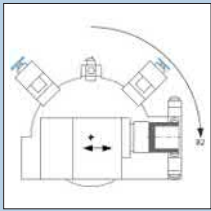

WORKPIECE CARRIER

- Work head
- Max. 3 dressers
- Steady rests
- Power clamping device
- B2-axis (optional)



DRESSING UNITS

- Max. 3 dressers
- Up to 2 rotating dressers
- Firm dressing diamonds
- Form and profile rolls



STEADY RESTS

- Hydraulic steady rests
- 3-jaw steady rests

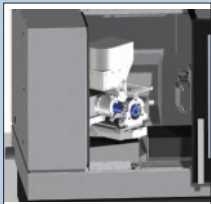

B2-AXIS

- Easy workpiece changeover
- Minimized dresser collision problematics
- Collision-free measuring position



INTEGRATED LIFTING SYSTEM

- Ergonomic Lifting system for table constructions

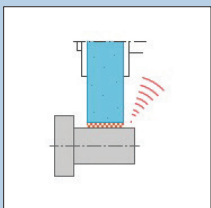

CONTACT SENSING

- Gap control with up to 4 sensors
- Operation and display integrated into the controller

WORKPIECE CARRIER

Various steady rests can be installed on the workpiece carrier, such as tracking hydraulic grinding steady rests. The integrated lifting system can be used for lifting table constructions. This saves the crane of the machine.

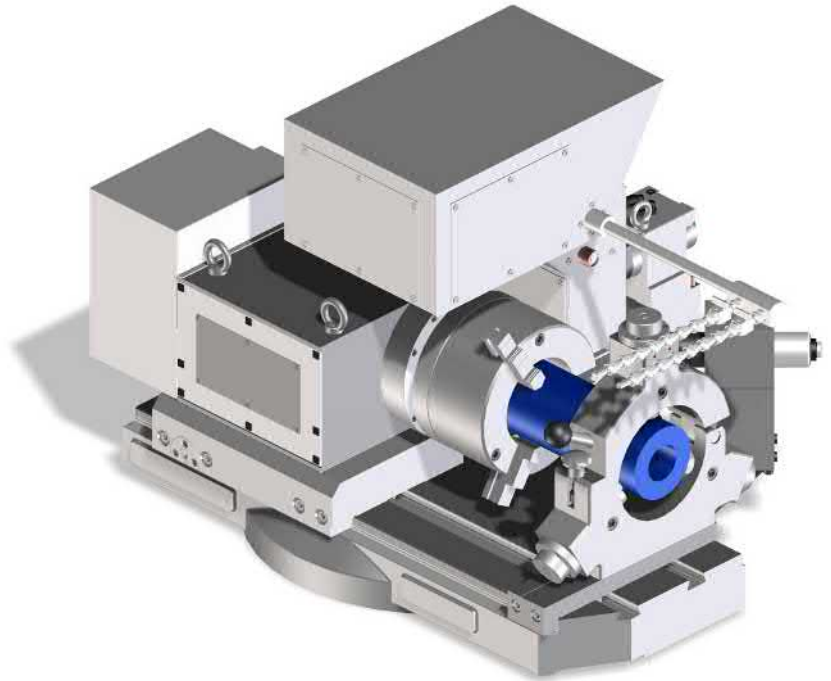

B2-AXIS ROTATING PART

An additional B2-axis can be added optionally on the workpiece carrier side. This offers the following advantages:

- Collision-free dressing
- Improved accessibility while measuring
- Easy workpiece changeover
- 3 dressing positions
- Automation of the loader system

The high-precision direct drive rotation axis can alternate between the grinding and dressing positions in < 2 seconds. The B2-axis has resolution of 1×10^{-8} degree and distortion-free clamping.

C-AXIS

With the possibility of X- and C-axis interpolation, VOUMARD 1000 allows grinding of non-cylindrical forms such as polygons, free contours and eccentrics. The rotary encoder with resolution of 1×10^{-7} degree is installed directly on the work head. The non-circular motion is superimposed onto the grinding motions, so that the grinding machine can fall back on any grinding cycle including handwheel release for the X-axis.

WHEEL HEAD

The modular construction of the turret wheel head allows the 4 grinding spindle positions to be specified individually. The Internal grinding wheels measure up to max. \varnothing 150 x 40 mm. The external grinding wheels up to \varnothing 300 x 40 mm. Thanks to the flexible equipment, inside and outside diameters can be ground as well as flat surfaces.

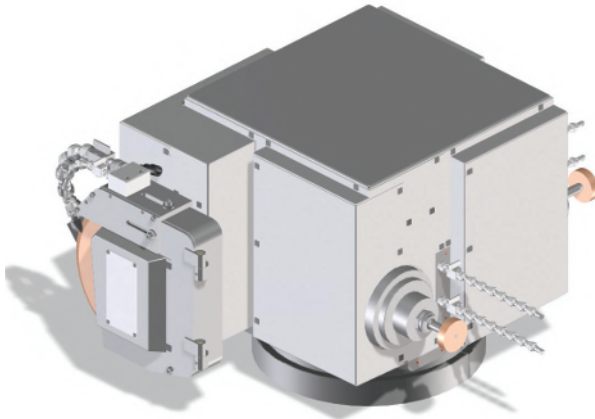

B1-AXIS ROTATING PART

A high-precision rotating axis is installed for faster positioning of the wheel head. Workpiece changeover lasts < 2.5 seconds. The B1-axis with direct drive has a resolution of 1×10^{-8} degree and distortion-free clamping.

With the B1-axis, up to 4 grinding spindle positions can be swiveled to the grinding position. Additionally, a fixed tactile measuring probe attached to the base body can be used for measurement tasks. The tactile measuring probe can measure internal and external diameters, shoulder positions and shoulder distances.

WORKPIECE MEASUREMENT SYSTEM

Automatic grinding wheel measurement. When swiveling the wheel head into the desired angular positions, the positions of the grinding wheel edges are automatically calculated. This offers the following advantages for the user:

- Programming with the effective masses according to the workpiece drawing and regardless of the swivel angle of the wheel head
- Renewed calibration of the swiveled grinding wheel is not required
- Simple and quick recording of the grinding wheel data when re-equipping the machine
- Workpiece management for external, surface and internal grinding is already integrated

TURRET WHEEL HEAD

- Individually configurable
- Compact
- 4 spindle positions
- FEM optimization
- Aluminum cooling-line

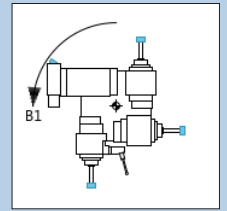

INTERNAL GRINDING EQUIPMENT

- Oil-air lubricated HF internal grinding spindle of max. 120,000 rpm (depending on the spindle)
- Powerful and universal
- With or without process coolant through internal grinding spindle
- Grinding wheel measurements up to \varnothing 150 x 40 mm

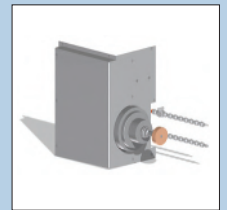

EXTERNAL GRINDING EQUIPMENT

- External grinding with water-cooled motor spindles and 12.7 kW performance
- Oil-air lubrication guarantees long durability
- Grinding wheel measurements up to \varnothing 300 x 40 mm

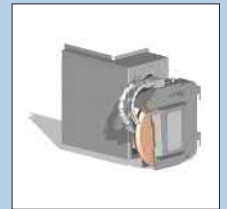

TACTILE MEASURING HEAD

- Mounted on the wheel head
- Orientation of the workpiece position in X-, Z- and C-position
- Active measurement of the diameter and length

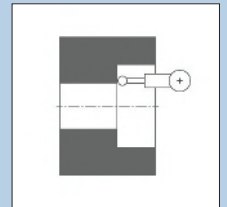

BALANCING

- Mounted on the wheel head

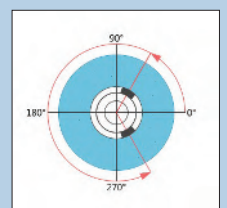

FANUC CONTROLLER 31i – WITH KELLENBERGER HMI

The **BLUE Solution interface** from KELLENBERGER has a central focus on productive and flexible operation. All interactions are carried out by gestures on the 19" touch display. The latest generation of a reliable FANUC 31i controller runs in the background.

BLUE SOLUTION



The user interface was developed explicitly for grinding by our specialists in cooperation with customers. BLUE Solution supports users regardless of their level of experience in all important steps from setup to production.

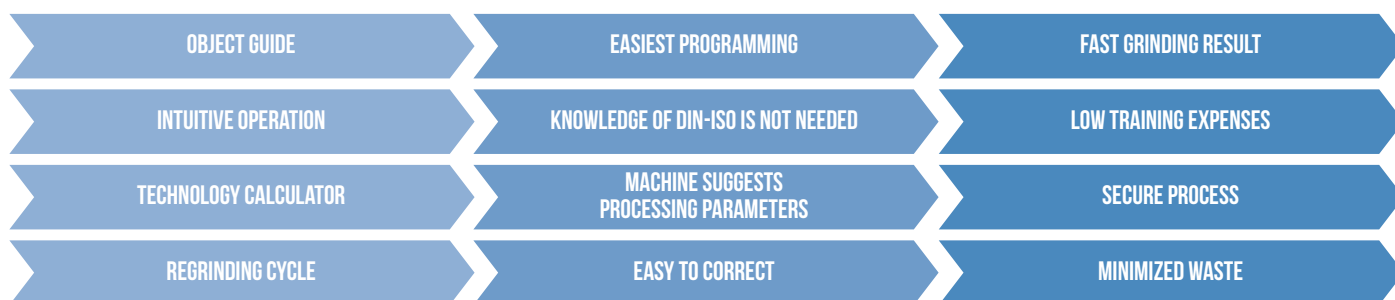

BLACK CAM SOLUTION

NC programs for grinding and non-cylindrical grinding, grinding and truing of profiles and screw threads can be generated, simulated and analyzed with the additional BLACK CAM Solution software. The CAD-CAM software supports the structured creation, processing and management of all documents belonging to a workpiece.

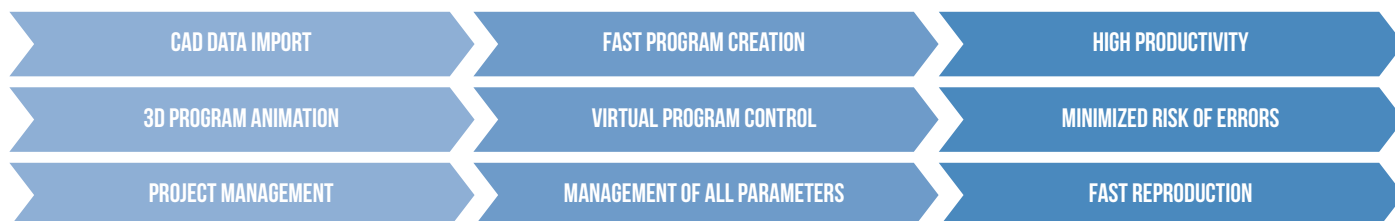

INDUSTRY 4.0

The Security Interface ensures communication between the machine and the production network according to the highest IT security standard.

The optional Remote Diagnostic module facilitates efficient diagnosis in service cases and thus reduces downtimes. The machine is ready for Industry 4.0. With the ComGateway, which has a standard OPC-UA server, extensive information on process and machine status can be exchanged.

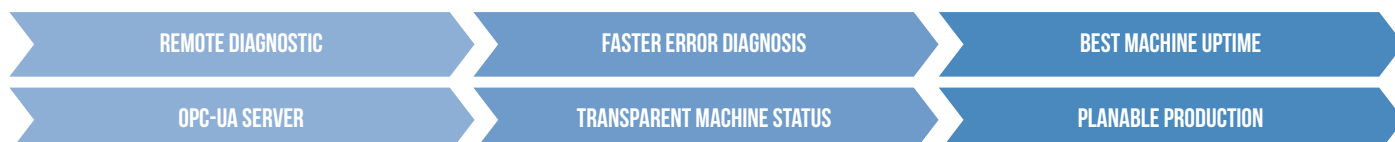

Characteristics		
Max. workpiece length	mm	300
Swing diameter	mm	<300
Max. workpiece diameter	mm	<150 / <300
Supply voltage	V	400 / 460
Power consumption	A	35 - 80
Atmospheric pressure	bar	5.5
Total weight	kg	5,800
Floor loading	N/m ²	8,100
X- / Z-axis		
Travel	mm	450
Speed	m/min	<20
Resolution	mm	2.5 x 10 ⁻⁶
B axis		
Instrument swivel range	°	330
Workpiece swivel range	°	225
Resolution	°	1 x 10 ⁻⁸
Turret wheel head		
Rotational speed range (depending on the spindle)	rpm	<120,000
Max. number of spindles	-	4
Peripheral speed	m/s	50
Internal grinding wheel	mm	max. 150x40
Max. internal grinding length	mm	250
Mounting hole of the internal grinding spindle	mm	150
External grinding wheel	mm	300x40
Max. external grinding length	mm	150
Work head		
Rotational speed range	rpm	1-1,000 / 1-3,000
Mounting cone	-	MK5 / -
External short taper adapter	-	ISO 702-1: Size 5 / size 3
Workpiece weight	kg	<200 / <50
Load on chucked work	Nm	<320 / <100
Resolution	°	1 x 10 ⁻⁷ /-
CNC controller		
Fanuc	-	Fanuc 31i

Information on dimensions, weight and construction is subject to changes

SETUP PLAN 300

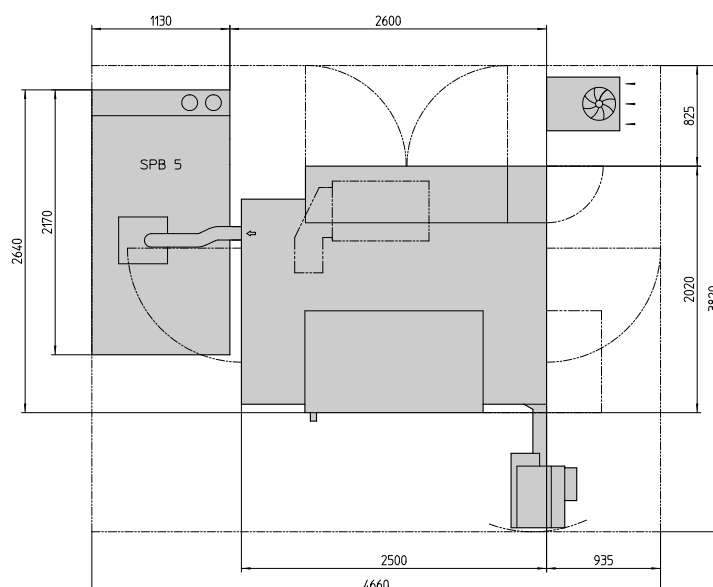

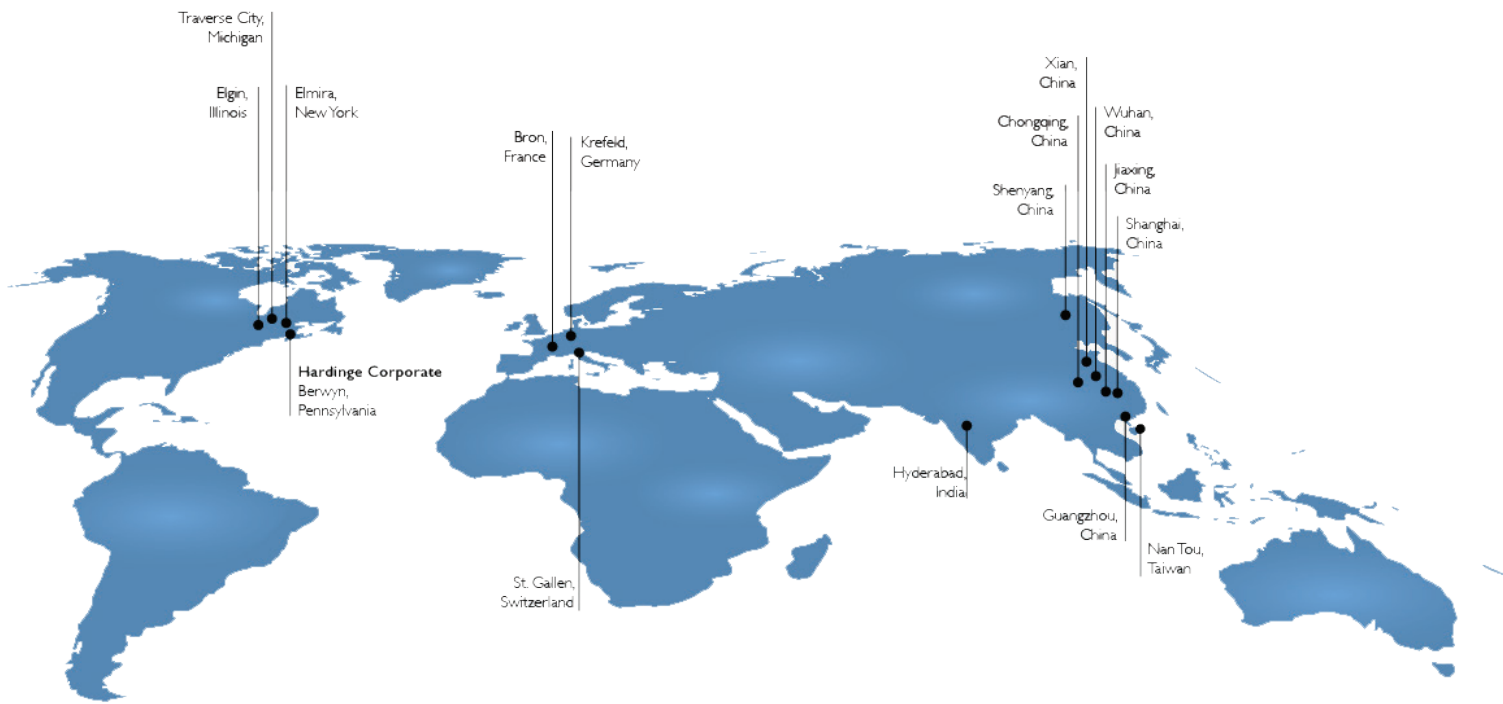

HARDINGE WORLDWIDE

Hardinge is a leading international provider of highly advanced machine tools and system solutions. We offer a comprehensive range of reliable CNC truing, milling and grinding machines as well as technologically advanced workpiece clamping systems.

Our advanced products are used in a variety of industries, including aerospace, agriculture, automotive, construction, energy, medical technology, transportation and more. We are a company with a strong global presence with manufacturing facilities in Europe, North America and Asia.

Hardinge uses its entire development and application know-how to always be able to offer your company the optimal machine tool solution and perfect service.

AMERICA

Pennsylvania
 Hardinge Corporate
 1235 Westlakes Drive
 Suite 410
 Berwyn, PA 19312
 Phone 800-843-8801
info@hardinge.com

New York
 Hardinge
 One Hardinge Drive
 Elmira, NY 14903
 Phone 800-843-8801
info@hardinge.com

Illinois
 Hardinge
 1524 Davis Road
 Elgin, IL 60123
 Phone 800-843-8801
info@hardinge.com

ASIA

China
 Hardinge Machine
 (Shanghai) Co. Ltd.
 1388 East Kangqiao Road
 Pudong, Shanghai 201319
 Phone 0086 21 3810 8686

Taiwan
 Hardinge Taiwan Precision
 Machinery Limited
 4 Tzu Chiang 3rd Road
 Nan Tou City 540
 Phone 886 49 2260 536
cs@hardinge.com.tw

EUROPE

France
 Jones & Shipman SARL
 8 Allee des Ginkgos
 BP 112-69672
 Bron Cedex

Germany
 Hardinge GmbH
 Fichtenhain A 13c
 47807 Krefeld
 Phone 49 2151 49649 10
info@hardinge-gmbh.de

Switzerland
 L. Kellenberger & Co. AG
 Heiligkreuzstrasse 28
 CH 9008 St. Gallen
 Phone 41 71 2429111
info@kellenberger.net



WWW.HARDINGE.COM

All prices and specifications are subject to change without notice. All brands marked with ® and ™ are trademarks of their respective owners. #1213-3E© Hardinge Inc. • 06/2020