

S36

EXTERNAL CYLINDRICAL PRODUCTION GRINDING MACHINE



STUDER S36 IN USE

The S36 was in part designed to respond to increasing demand for e-mobility production solutions. The machine has a grinding wheel with a diameter of 610 mm (24") and width of 125 mm (4.92") for grinding current and future workpieces in this sector both economically and efficiently. Grinding wheel power of 15 kW (20 HP) and the large grinding wheel enable efficient and safe machining of automotive and hydraulic components in one clamping process with maximum precision.



S36

DIMENSIONS

- Distance between centres 650 mm (24.6")
- Centre height 225 mm (8.85")
- Grinding wheel diameter 610 mm (24")

HARDWARE

- External wheelhead with grinding wheel right, 0° / 15° / 30°
- Frequency-controlled motor grinding spindle for external grinding
- C axis for workhead
- Worktable with integrated double T-slot for dressing unit
- C.O.R.E. Panel
- Portable control unit (PCU) for setting up close to the grinding process
- Full enclosure with two sliding doors
- Granitan® S103 mineral-cast machine base

SOFTWARE

- C.O.R.E. OS operating system
- Very simple programming thanks to StuderPictogramming
- Standardized interfaces for loader and peripheral units
- Flexibly upgradeable with integrated software modules
- StuderWINprogramming software (optional) for creating grinding and dressing programs on an external PC

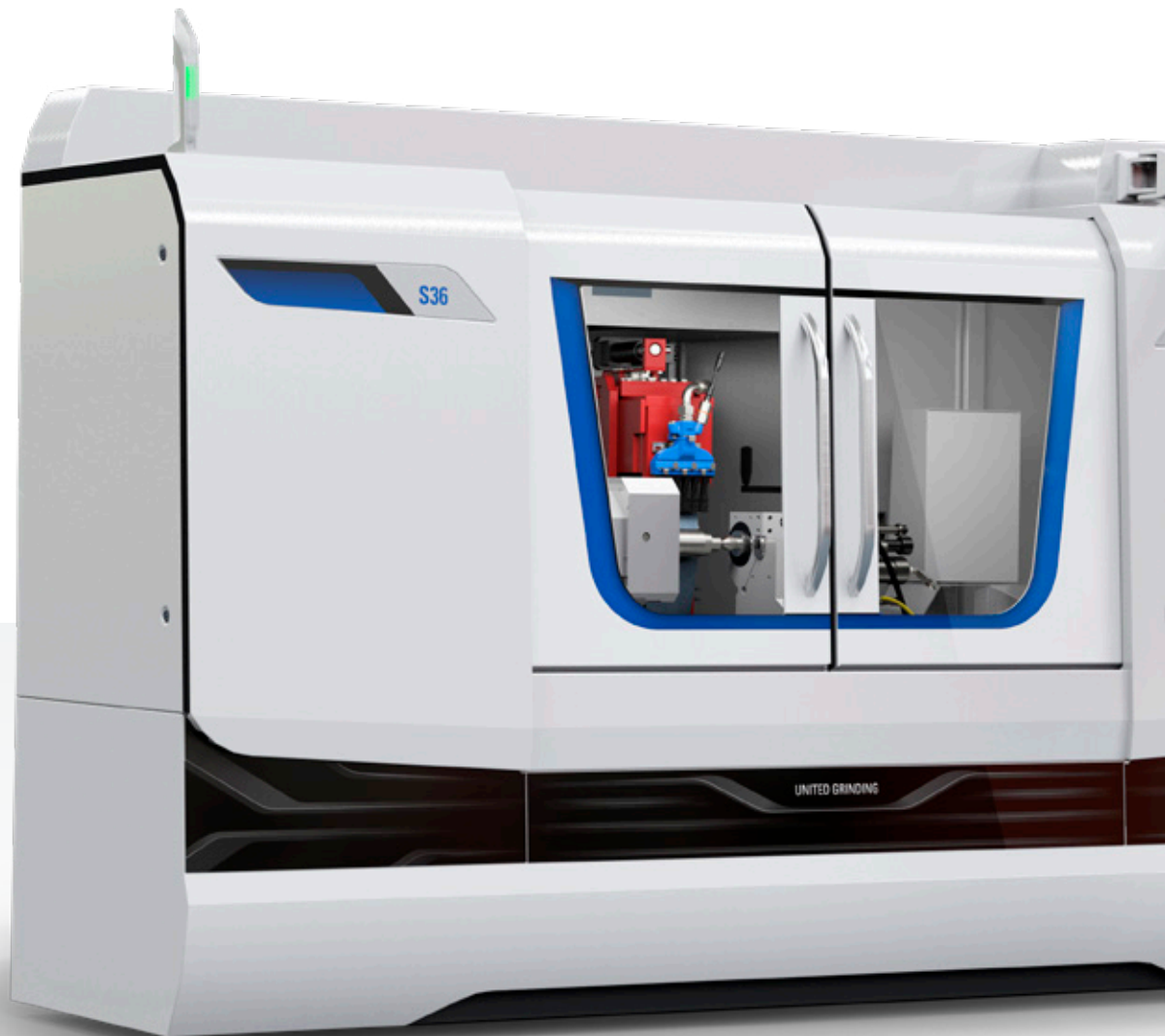

YOUR BENEFIT

- Increased productivity thanks to large grinding wheel and higher spindle power
- Modern cooling thanks to SmartJet®
- Maximum precision due to perfect interplay between hardware and software
- Intuitive, user-friendly, and efficient operation
- Access to important information directly at the panel (e.g., production progress, job details etc.)
- Reduced programming effort for data exchange between C.O.R.E machines
- Use of UNITED GRINDING Digital Solutions™ products directly at the machine
- Fast support thanks to interaction with our Customer Care team at the machine
- Environmentally friendly thanks to specific measures to reduce energy consumption
- Ergonomic thanks to large sliding doors and three service doors



“The high-performance machine for automated processes.”

C.O.R.E. – CUSTOMER ORIENTED REVOLUTION

C.O.R.E. helps us make your production fit for the digital future.

It is based on a new operating system, C.O.R.E. OS that equips the machine with intelligence.

Thanks to the uniform C.O.R.E. software architecture, exchanging data between UNITED GRINDING machines is easy. The integrated umati API can be used to communicate with third-party systems as well. It also offers access to UNITED GRINDING Digital Solutions™ products directly on the machine. C.O.R.E. not only establishes the technical foundation for this and other IoT and data applications, it also forms the basis of revolutionary yet uniform operation.

What does this mean for you?

- The user-friendly, intuitive, and uniform operation makes work easier for machine setters, machine operators, and maintenance staff
- Standardized data collection and intelligent processing of data creates transparency and supports process optimization
- The uncomplicated and consistent use of modern digital software solutions is guaranteed – directly on the machine
- The technical platform for the use of modern IoT and data applications has been established

C.O.R.E. ELEMENTE

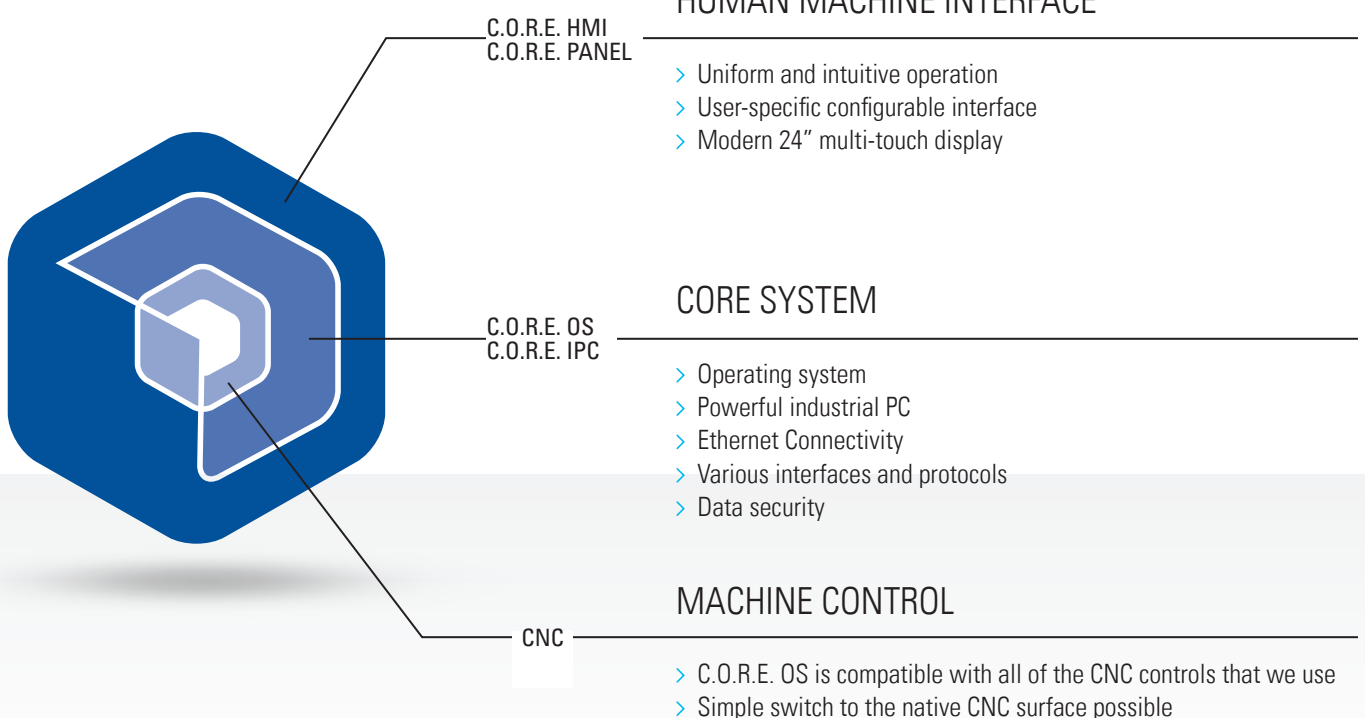

C.O.R.E. PANEL – THE FUTURE OF OPERATION

Intuitive

Thanks to intuitive design with self-explanatory icons, navigation through the machine menu and process steps is quick and easy. Instead of buttons, the user is presented with a modern and clearly arranged multi-touch display.

User-friendly

Each user configures their own user interface individually. This is called up automatically with the RFID chip after logging in. When the user leaves the machine, the panel switches to "Dark Factory Mode". Production progress and the machine state are also clearly visible from a

distance. And thanks to the ergonomic design, the panel can be tilted and individually adjusted easily.

Efficient

The uniform and intuitive operating philosophy reduces training time. The configurable and role-specific interface helps prevent errors and increases the efficiency and quality of programming. Information can be exchanged quickly and in real-time via the front camera and Bluetooth headset. UNITED GRINDING Digital Solutions™ products can be used directly on the panel.

INDUSTRIAL
MULTI-TOUCH DISPLAY

INTEGRATED
FRONT CAMERA

SELF-EXPLANATORY
ICONS

USER-CONFIGURABLE
DISPLAY

STANDARDIZED
FUNCTION KEYS

ERGONOMIC
OVERRIDE SWITCH



Technical Specifications

- 24" Full HD multi-touch display
- 16-position rotary override switch
- Electronic key switch (RFID)
- Integrated front camera
- Bluetooth V4.0 for headset connection
- 2x USB 3.0 ports
- Adjustable tilt

STUDERWIN OPERATOR INTERFACE

The user interface StuderWIN creates a stable programming environment and contributes to efficient use of the machine. The possibility of fully integrating the in-process gauging and sensor technology for process control as well as contact detection and automatic balancing systems in the operator interface enables standardized programming of the different systems. The software of an optional loading system is also integrated. The drive elements are optimally matched to the control system.

The sophisticated mechanical engineering concept of the S36 is completed by a grinding software program developed in-house by STUDER and which is continuously optimized in collaboration with users of the software. This software offers:

- **StuderPictogramming:** The operator strings the individual grinding cycles together – the control unit generates the ISO code.
- **Microfunctions:** Free programming of grinding and dressing process sequences for optimization of the grinding process.
- **Integrated operating instructions** assist safe machine operation.
- The software options for the grinding technology calculations, optimized dressing as well as the contour, thread- and form-grinding cycles increase the functionality of the machine.
- **InOne GRIND:** The cylindrical grinding cycle can be programmed specifically for the individual grinding task via the clear menu.

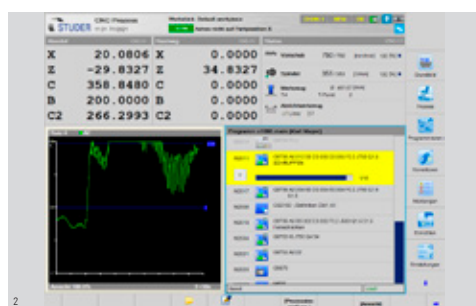
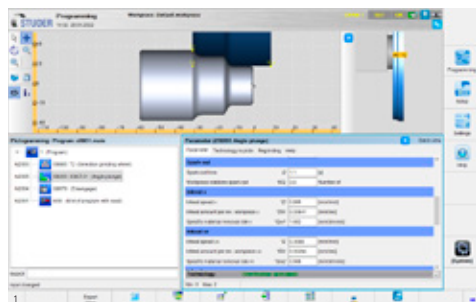

1 Programming interface with StuderPictogramming

2 Process screen

StuderTechnology integrated – more than 110 years of expertise

StuderTechnology integrated drastically simplifies the operation of cylindrical grinding machines. Component quality, machining time, energy efficiency – all important production factors, in short: all important production factors benefit massively. What makes the software unique? It is a combination of grinding technology formulas, empirical data and many years of expert knowledge. The program contains data from countless grinding tests, during which the best processing strategy was determined in each case for a wide range of components. StuderTechnology integrated makes specific use of these values depending on the specific application. This integrated grinding knowledge can be further optimized as required by the individual grinding experts and can be stored as a customer-specific production specification. This also enables the less experienced operator to benefit from STUDER expertise.

Integrated tools

The functionality of STUDER grinding machines can be significantly increased through numerous enhancement packages. STUDER offers the required software packages in the form of integrated tools.

- **StuderDress Integrated** reduces the profiling time of a grinding wheel by up to 80%.
- **StuderThread Integrated**, together with the Studer thread grinding cycles, offers the full functionality that is otherwise only possible with a special thread grinding machine.
- **StuderContourBasic Integrated** is ideal for generating geometry contours with the grinding wheel in an easy, quick and safe manner.
- **StuderContourPRO Integrated** generates the complete grinding program for complex external geometries, typically for peel grinding from solid material.
- **StuderForm Integrated** is the universal non-circular grinding software for machining curves and polygons for standard applications in low volume production.

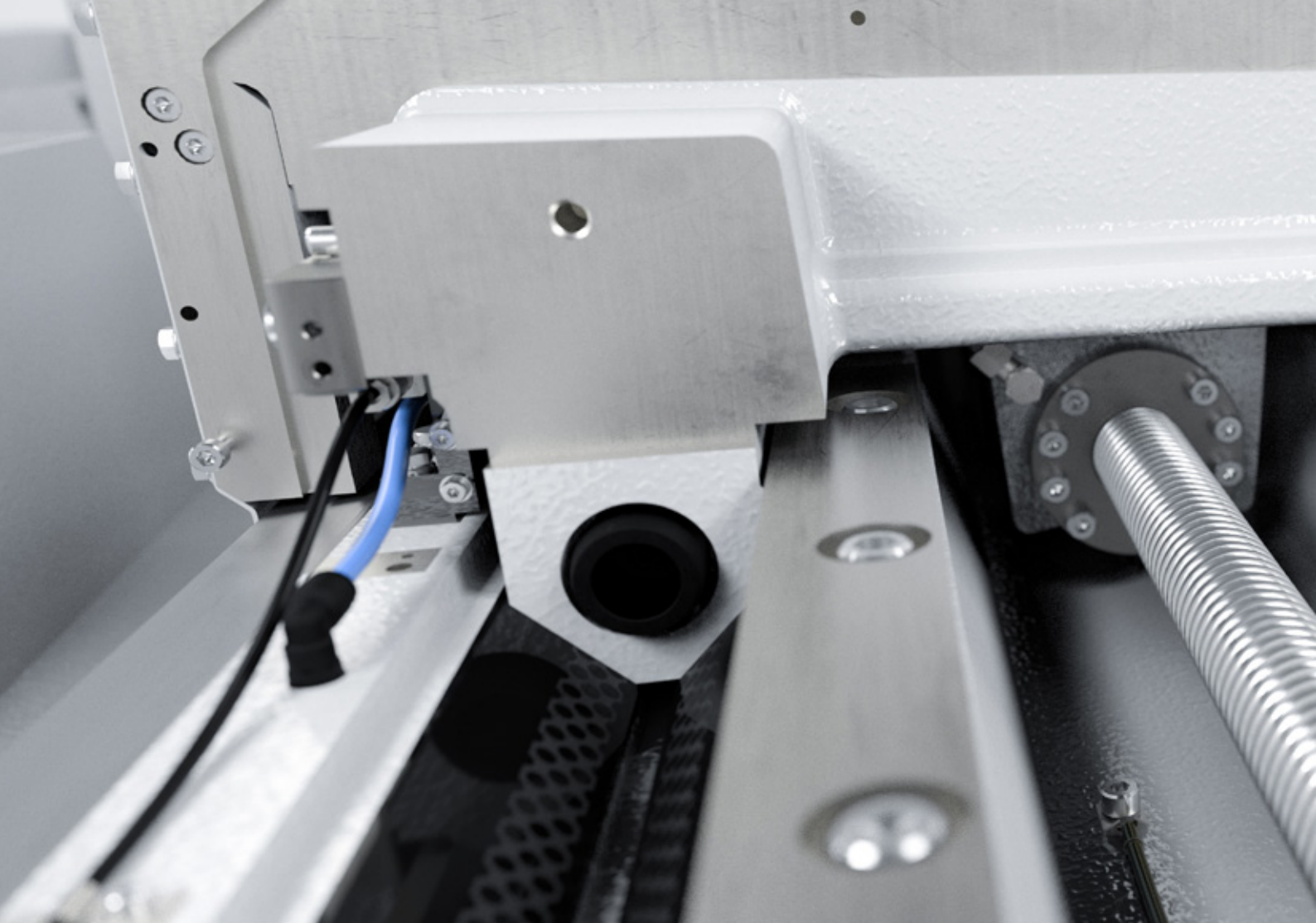

GRANITAN® S103 MINERAL CASTING MACHINE BED

The material structure developed by STUDER to its own formula and proven over the years is produced in a plant using state-of-the-art industrial techniques. The excellent dampening characteristics of the machine bed ensure outstanding surface quality of the ground parts. The service life of the grinding wheel is also increased, leading to reduced non-productive times. Temporary temperature fluctuations are largely compensated by the favorable thermal behavior of Granitan®. This provides high dimensional stability throughout the day. The guideway system for the longitudinal and cross slides is formed directly in the machine bed and is coated with the Granitan® S200 wear-resistant guideway surfacing material. The guideways offer the highest possible accuracy through the entire speed range with high load capacity and dampening. Thanks to the robust and maintenance-free design, these excellent guideway characteristics are retained almost indefinitely.

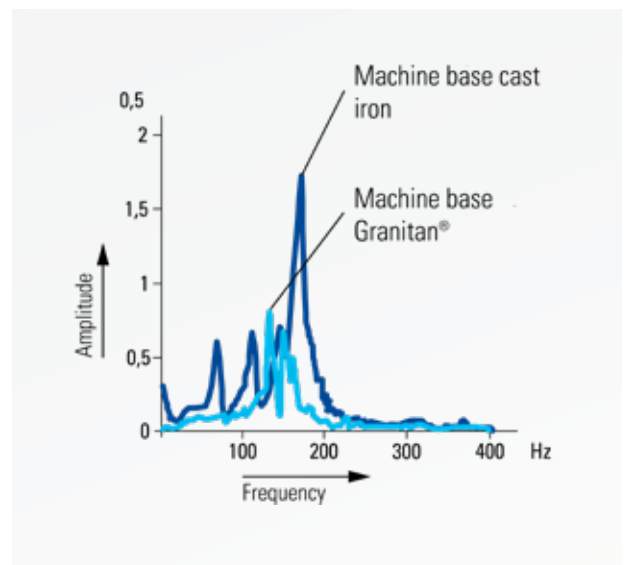

- Vibration-dampening
- Thermally stable
- Non-wearing

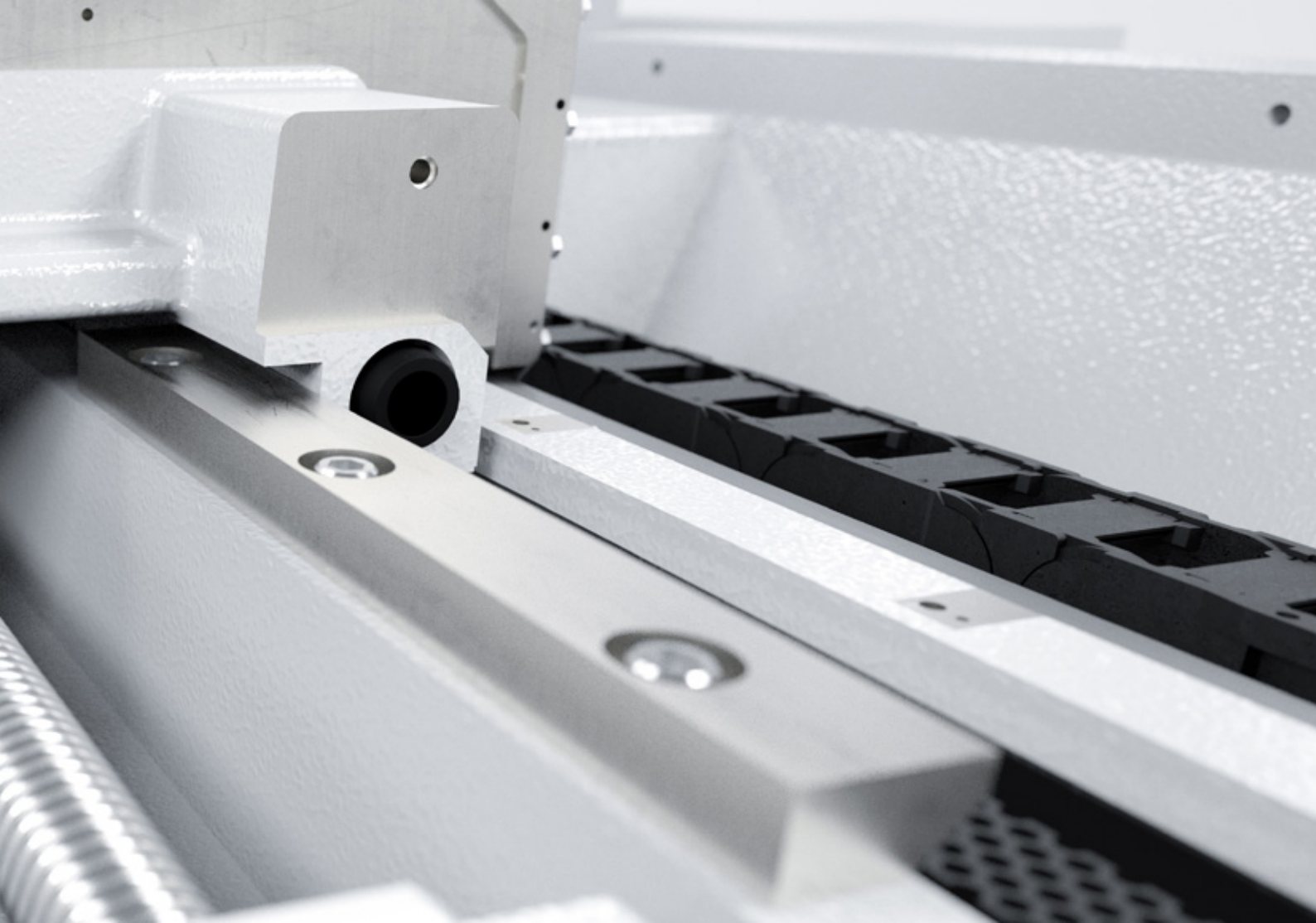

STUDERGUIDE® IN LONGITUDINAL AND CROSS SLIDES

The longitudinal and cross slides are manufactured from high-quality gray cast iron and have highly precise, ground guideways. The slides rest completely on the guideways of the machine bed through the entire traversing range. This provides the cornerstone for the excellent straightness of 0.0025 mm (0.000,10") over 650 mm (25,6") measured length. The top of the longitudinal slide has a surface that is ground over its entire length and acts as a support for the workhead, the tailstock, as well as accessories and devices. A setup scale, recessed in the table, makes it easy to set up and reset the components on the table.

An additional T-slot with a ground surface enables the optimal utilization of dressing devices. The newly developed StuderGuide® guide system extends the advantages of hydrostatic systems and guideways with patented surface structure. A major advantage of StuderGuide® compared to hydrostatic guideways is the damping component in the direction of movement.

The slides are driven by recirculating ball screws which are connected via torsionally stiff bellow-couplings with the three-phase servo motor.

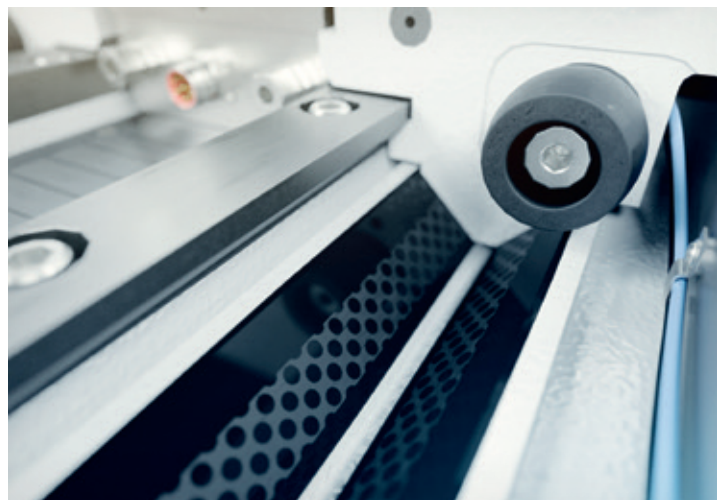

- High geometrical travel accuracy
- Setup scale for setup and resetting
- Effective covering of guideways

WHEELHEAD

The machine has a fixed wheelhead and is available in 0°, 15° or 30° versions. The tool is in T2 (wheel right) and is geometrically optimized for the grinding spindle that is used.

The grinding wheel dia. 610 × 80 mm (dia. 24" × 3.15") is powered by a 11.5 kW (15.4 HP) belt-driven spindle, while the version with dimensions dia. 610 × 125 mm (dia. 24" × 5") is driven by a 15 kW (20 HP) motor spindle.

The motor spindle can be optionally fitted with a hollow shaft, enabling automatic fine balancing.

Process cooling is taken to a higher level thanks to SmartJet®.

The newly developed flow-optimized nozzles enable the efficient, precise and reproducible supply of cooling lubricant. Thanks to this, the cooling system is now part of the machine control.

- Motor spindles
- High cutting speed
- 1 tool (external) for productive machining
- Energy-efficient SmartJet® coolant nozzles



WORKHEAD

All requirements are covered by the wide range of workheads. They are all solidly built in the superior STUDER quality and achieve roundness accuracies of 0.0004 mm (0.000,016"), or optional 0.0002 mm (0.000,008"), with live spindle grinding. The simple cylindricity correction contributes towards perfect live spindle grinding results. Custom-specific workpiece clamping and carrier systems can be easily used.

- High roundness accuracy
- Low maintenance
- Air cushion

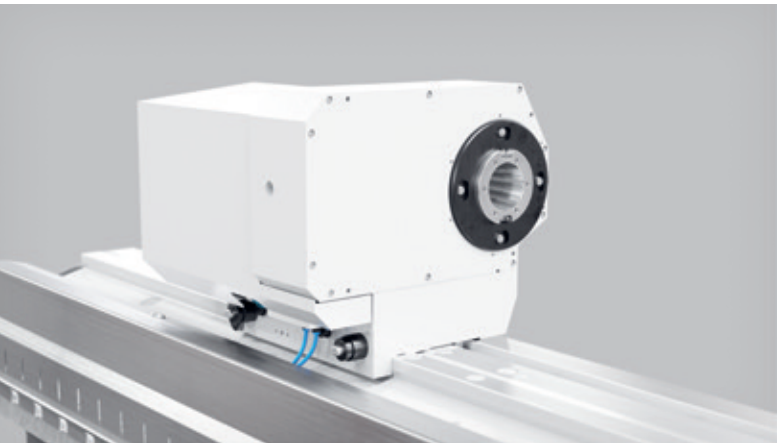

Universal workhead

For external grinding between fixed centres or for live spindle grinding. The spindle is clamped for grinding between fixed centres. C axis applications are possible with the indirect measuring system.

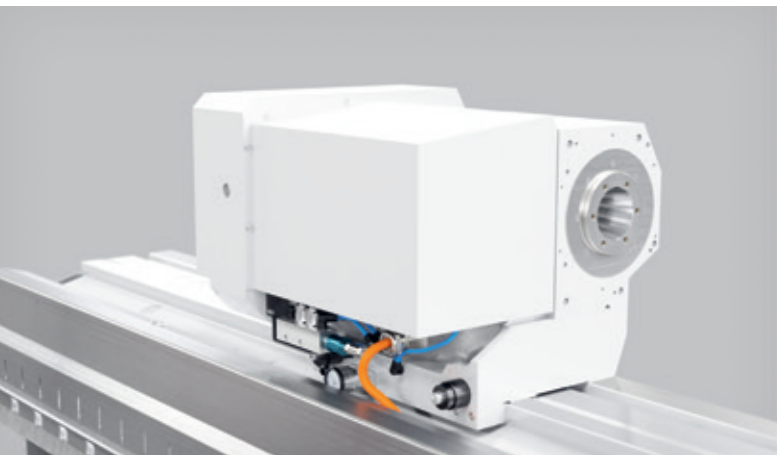

Chuck workhead

For live spindle grinding or external grinding with rotating centres. Thanks to the design, with drive via a rear belt, high loads are possible with live spindle grinding. C axis applications are possible with the indirect measuring system.

TAILSTOCK

Designed for the use of centres with morse taper 4, the generously dimensioned barrel slides inside the tailstock housing. The centre pressure can be adjusted with the delicate precision required for grinding high-precision workpieces. The tailstock can be equipped with a hydraulically actuated barrel retraction for workpiece change-over. The

fine adjustment enables cylindricity corrections in the range below $1\ \mu\text{m}$ (0.000.040") when grinding between centres. An air cushion lift-off facilitates simple movement during setup and resetting. Cooling lubricant flows through the tailstock; barrel and diamond holder are flooded to ensure optimum thermal stability.

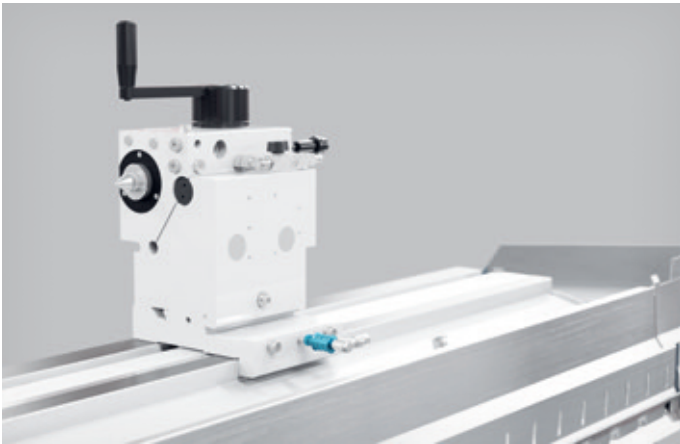

Tailstock

Clamping takes place via a spring. This tailstock is suitable for workpiece weights up to 150 kg (330 lbs).

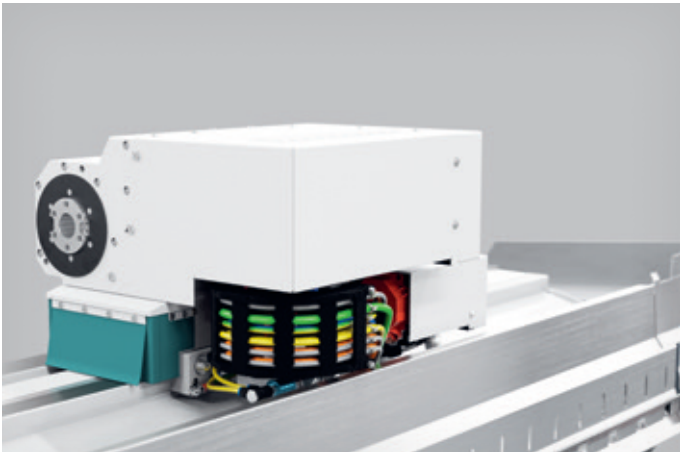

Synchronous tailstock

Use of the synchronous tailstock is particularly cost-effective when manufacturing part families, when grinding a workpiece over its entire length or if the use of a conventional driver is not possible. Workpiece weight up to 80 kg (176 lbs).

- Programmable clamping force
- Cylindricity correction
- Thermal stabilization by flooding

DRESSING

An easy-cutting grinding wheel is essential for cost-effective and high-quality grinding. STUDER offers a large selection of dressing units, to coordinate the dressing process flexibly and optimally with the properties specific to the workpiece, tool or materials. The grinding wheel profile and dressing parameters are easily defined via macros. Another STUDER speciality is the grinding wheel reference points (T-numbers).

These allow programming with nominal dimensions, which simplifies the creation of grinding programmes considerably.

A software package is available to fine tune the dressing process and includes additional dressing functions.



Rotative dressing

Rotative dressing tools are particularly suitable for dressing CBN grinding wheels.



Diamond holder behind tailstock

The clamping surface with double T-slots is suitable for different dressing tools.

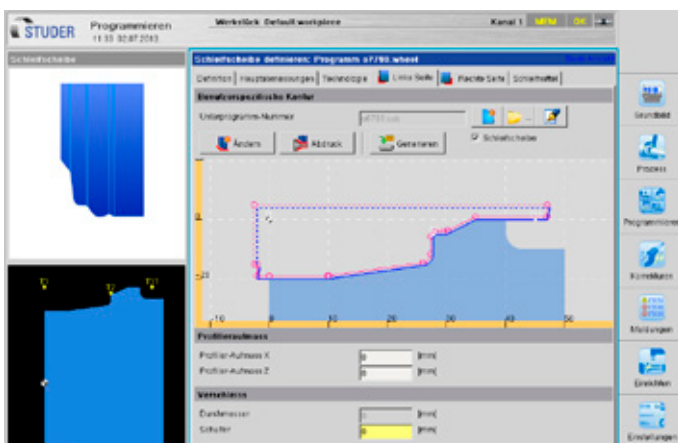

Dialogue screen dressing parameters

Easy adjustment of free wheel shapes with grinding wheel imprint from workpiece drawing.

AUTOMATION

There are various loading systems available that, thanks to their modular design, can be precisely matched to your machine use and machining processes. The appropriate peripherals ensure seamless integration into the respective production process. Using a data matrix code reader or a laser labeling machine, each workpiece is assigned its own identity; process data can be traced at all times. The handling systems communicate with the machine via the standardized loader interface and enable even complex handling tasks to be solved. Project-specific components such as pre- and post-measurement stations, de-burring

and blowing-off stations, calibration part repositories etc., can be implemented in the system. Comprehensive quality control is possible during the grinding process. This entails: in-process, post-process, recording, evaluation and correction. In grinding, especially in match grinding, such quality assurance is crucial.





CUSTOMER CARE

WE ARE HERE FOR YOU!

Our products are designed to meet customer demands for as long as possible, operate efficiently, reliably and be available at all times.

From "Start up" through to "Retrofit" – our Customer Care is there for you throughout the working life of your machine. That is why over 200 competent service contacts worldwide in 10 different languages are available locally.

- We will provide you with fast, straight-forward support.
- We will help to increase your productivity.
- We work professionally, reliably and transparently.
- We will provide a professional solution to your problems.

UNITED GRINDING DIGITAL SOLUTIONS™

We develop solutions to support you in simplifying processes, boosting your machine's efficiency and increasing overall productivity under the "UNITED GRINDING Digital Solutions™" brand.

We are continuously expanding our solution portfolio in the key areas of **CONNECTIVITY**, **USABILITY**, **MONITORING**, and **PRODUCTIVITY** to make your work in the digital age significantly easier.

Find out more about UNITED GRINDING Digital Solutions™ services on our website in the Customer Care section.



Start up

Commissioning
Warranty extension



Qualification

Training
Production support



Prevention

Maintenance
Inspection



Service

Customer service
Customer consultation
Helpline



Digital Solutions

Remote Service
Service Monitor
Production Monitor

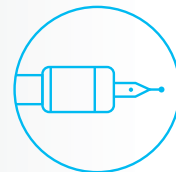

Material

Spare parts
Replacement parts
Accessories



Rebuild

Machine overhaul
Assembly overhaul



Retrofit

Modifications
Retrofits

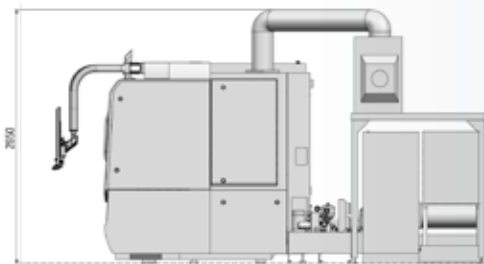
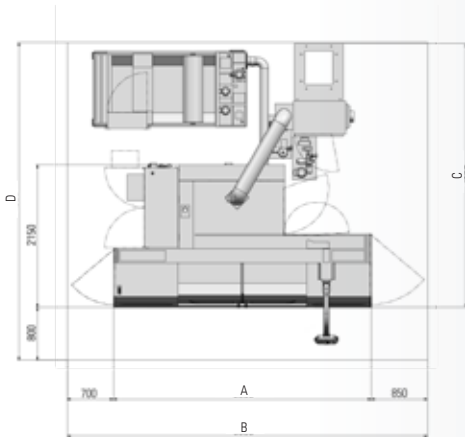

DIMENSIONS

A	B	C	D
3900 mm	5900 mm	4000 mm	4800 mm
(153.54")	(232.28")	(157.48")	(188.98")

TOTAL WEIGHT

Centre distance 650mm / 26"	9500 kg (20,940 lbs)
-----------------------------	----------------------

The information given is based on the technical levels of our machine at the time of this brochure going to print. We reserve the right to further develop our machines technically and make design modifications. This means that the dimensions, weights, colours, etc. of the machines supplied can differ. The diverse application possibilities of our machines depend on the technical equipment specifically requested by our customers. The equipment specifically agreed with the customer is therefore exclusively definitive for the equipping of the machines, and not any general data, information or illustrations.

TECHNICAL SPECIFICATIONS

MAIN DIMENSIONS

Distance between centres	650 mm (26")
Centre height:	225 mm (8.85")
Max. workpiece weight between centres	80/150 kg (176/330 lbs)

CROSS SLIDE: X AXIS

Max. travel	370 mm (14.56")
Speed	0.001–15,000 mm/min (0.000,040–590 ipm)
Resolution	0.00001 mm (0.4 mill")

LONGITUDINAL SLIDE: Z AXIS

Max. travel	800 mm (31.5")
Speed	0.001–20,000 mm/min (0.000,040–787 ipm)
Resolution	0.00001 mm (0.4 mill")

WHEELHEAD

Motor spindle	15 kW (20 HP)
Swiveling range	0° / 15° / 30°
Fitting taper	Dia. 73 mm
Driving power	max. 15 kW (20 HP)
Grinding wheel, dia. × width × bore	610 × 100 (125F5) × 203 mm 24" × 4" (5" Form5) × 8")
Circumferential Speed	Standard up to 50 m/s (9840 sfpm) Option up to 63/80 m/s (12,400/15,750 sfpm)

Belt-driven spindle	11.5 kW (15.4 HP)
Swivel range	0° / 15° / 30°
Fitting taper	Dia. 73 mm
Drive power max.	11.5 kW (15.6 HP)
Grinding wheel, dia. × width × bore	610 × 80 (F5) × 203 mm 24" × 3.15" (F5) × 8")
Standard circumferential speed	up to 50 m/s (9840 sfpm)

CONTROL

Fanuc 0i-TFP

GUARANTEED WORKING PRECISION

Straightness	
Measuring Gauge length 650 mm (25.6")	0.0025 mm (0.000,10")

CONNECTED LOADS

Total connected load	20 kVA
Air pressure	5.5–7 bar (80–100 psi)

UNIVERSAL WORKHEAD

Speed range	1–1,500 rpm
Fitting taper	MT4 / Dia. 70 mm
Spindle bore (feedthrough)	dia. 26 mm (1.02")
Driving power	3 kW (4 HP)
Load during live grinding	70 Nm (51.6 ft-lb)
Roundness accuracy during live spindle grinding	0.0004 mm (option: 0.0002mm) 0.000,016" (option: 0.000,008")

Speed range	1–1,000 rpm
Fitting taper	MT5 / Dia. 110 mm
Spindle bore (feedthrough)	Dia. 38 mm (1.495")
Driving power	4 kW (5.4 HP)
Load during live grinding	180 Nm (132 ft-lb)
Roundness accuracy during live spindle grinding	0.0004 mm (option: 0.0002 mm) 0.000,016" (option: 0.000,008")

C axis, indirect measuring system

CHUCK WORKHEAD

Speed range	1–1,000 rpm
Fitting taper	ISO50 / Dia. 110 mm
Spindle bore (feedthrough)	dia. 50 mm (1.97")
Driving power	4 kW (5.4 HP)
Load during live grinding	250 Nm (184 ft-lb)
Roundness accuracy during live spindle grinding	0.0004 mm (0.000,016") (option: 0.0002 mm (0.000,008") (option: 0.0002 mm)

C axis, indirect measuring system

TAILSTOCK

Fitting taper	MT3:	MT4:
Barrel stroke	35 mm (1.375")	60 mm (2.36")
Diameter of barrel	50 mm (1.97")	60 mm (2.36")
Fine adjustment for cylindricity corrections	±40 µm (±0.0016")	±80 µm (±0.0032")

SYNCHRONOUS TAILSTOCK

Fitting taper	MT4:
Travel range	120 mm (4.72")
spindle nose	Dia. 70 mm
Workpiece weight between centres	80 kg (176 lbs)
Fine adjustment for cylindricity corrections	±80 µm (±0.0032")

EXTRA-FINE GRINDING TAILSTOCK

Fitting taper	MT3:
Barrel stroke	35 mm (1.375")
Diameter of barrel	50 mm (1.97")
Automatic fine adjustment for cylindricity corrections	±40 µm (±0.0016")

FRITZ STUDER AG

The name STUDER stands for more than 110 years of experience in the development and production of precision cylindrical grinding machines. «The Art of Grinding.» is our passion, highest precision is our aim and top Swiss quality is our benchmark.

Our product line includes both standard machines, as well as complex system solutions in high-precision cylindrical grinding for machining small and medium-sized workpieces. In addition we offer software, system integration and a wide range of services. As well as receiving a complete tailor-made solution the customer also benefits from our 110 years of know-how in relation to the grinding process.

Our customers include companies from the machine tool industry, automotive, tool and die makers, the aerospace industry, pneumatics/hydraulics, electronics/electrical engineering, medical technology, the watch industry and contract manufacturing. They value maximum precision, safety, productivity and longevity. As one of the market and technology leaders in universal, external, internal cylindrical and non-circular grinding, with 25000 delivered systems, STUDER has stood for precision, quality and longevity for decades. STUDER's products and services include hardware, software and a wide range of services in the pre- and after-sales sector.



UNITED GRINDING GROUP

UNITED GRINDING Group is one of the world's leading manufacturers of grinding, eroding, laser, and measuring machines as well as machine tools for additive manufacturing. With roughly 2 500 employees at more than 20 manufacturing, service, and sales locations, the Group is organized in a customer-oriented and efficient way.

Through its MÄGERLE, BLOHM, JUNG, STUDER, SCHAUDT, MIKROSA, WALTER, EWAG, and IRPD brands, as well as competence centers in America and Asia, UNITED GRINDING offers broad application expertise, a large product portfolio, and a full range of services for the production of high-precision components.

«We want to make our customers even more successful»

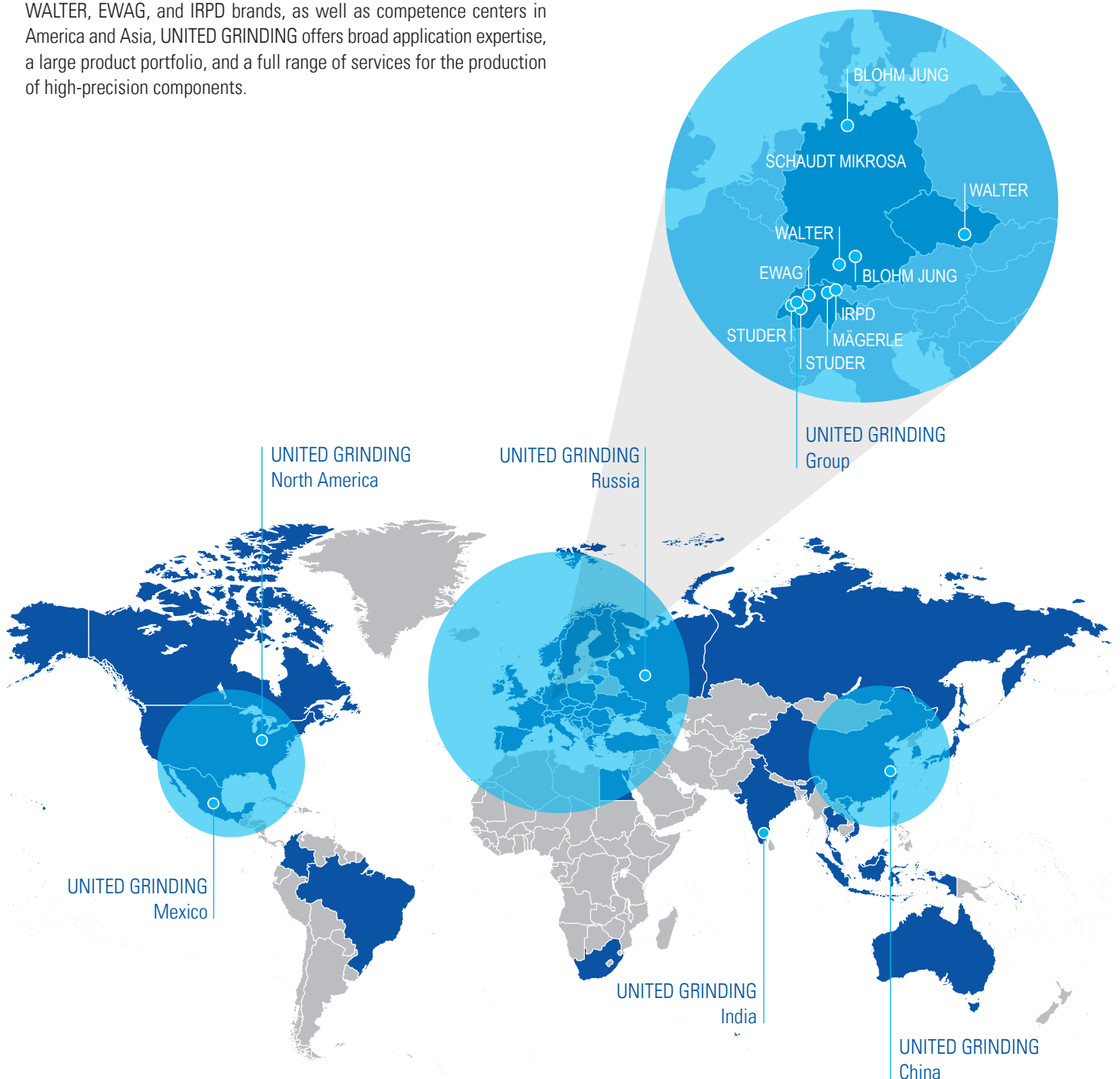



Fritz Studer AG
3602 Thun Switzerland
Switzerland
Phone +41 33 439 11 11
info@studer.com
studer.com



ISO 9001
VDA6.4
certified

